

1 2 3 4 5 6 7 8 9 10 11 12 13 14 15 16

A

A

B

B

C

C

D

D

E

E

F

F

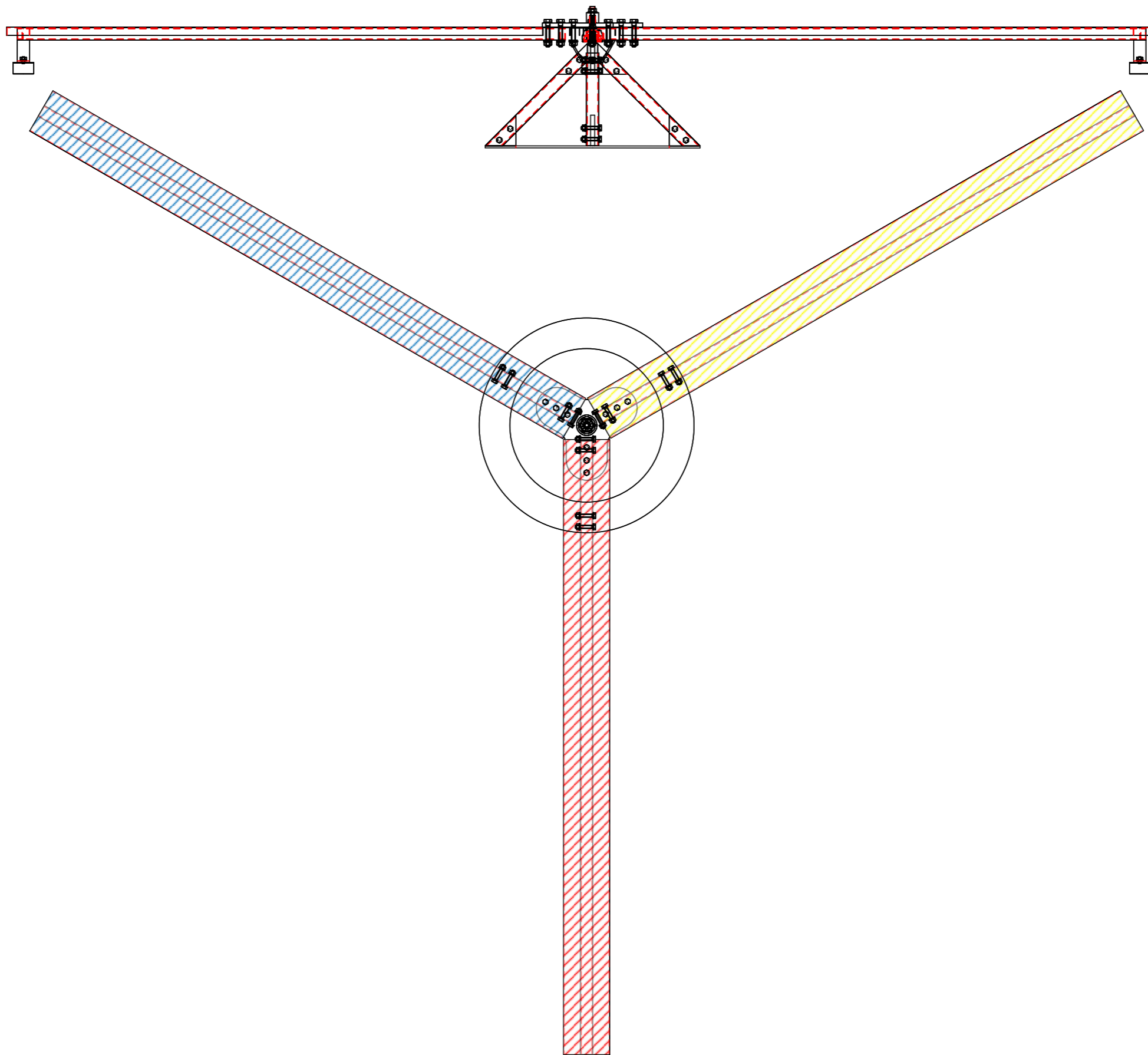

Bosun Brick Midrand
 a division of
Bosun Concrete Products (Pty) Ltd
Expect the Best

reHJon Balance Beam

Assembled

Project: reHJon Balance Beam

DRW No. 2019070300

For Quotation

Designed: H Jonker

Rev: 1

Page 1
Scale: 1:15
of 6 pages

1 2 3 4 5 6 7 8 9 10 11 12 13 14 15 16

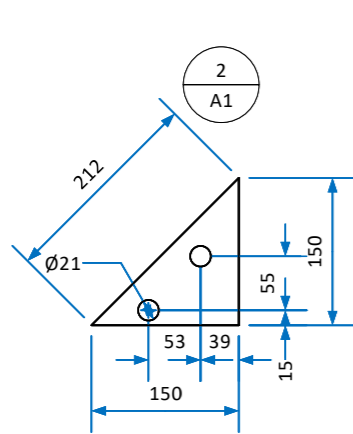

Cut 3 of 150 x 150 x 212 mm out off 20 mm mild steel plate with holes as per drawing.

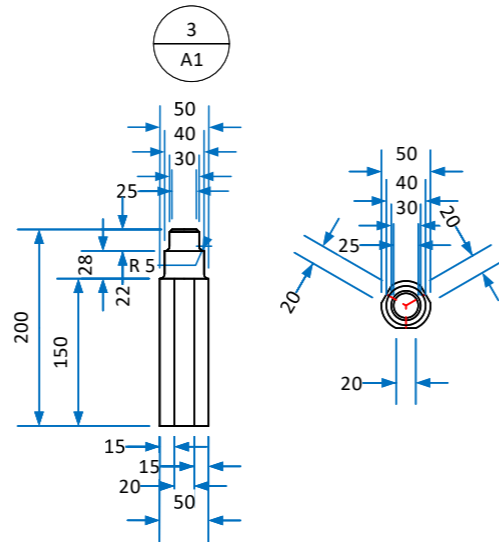

Manufacture the centre tripod shaft out of mild steel shafting as per drawing.

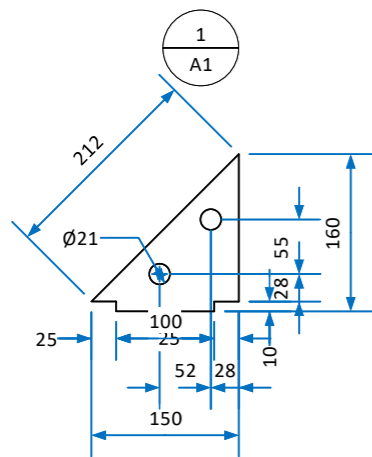
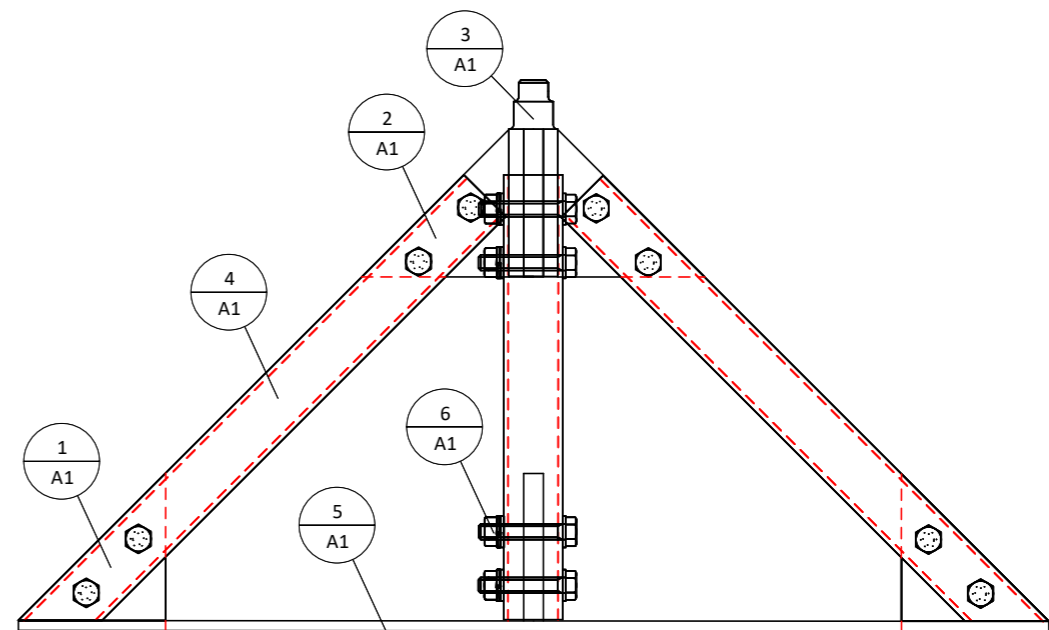

Cut 3 of 150 x 160 x 212 mm out off 20 mm mild steel plate with holes as per drawing.

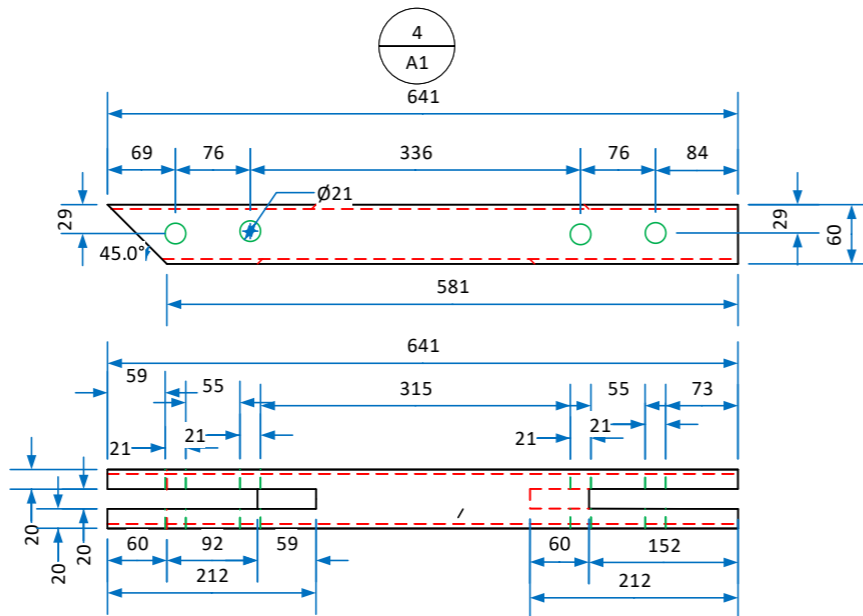

Manufacture 3 struts of 641 mm out off 60 x 60 x 4.5 mm mild steel square tubing. Drill holes as per drawing. A slot must be cut in to fit over the braces as per drawing.

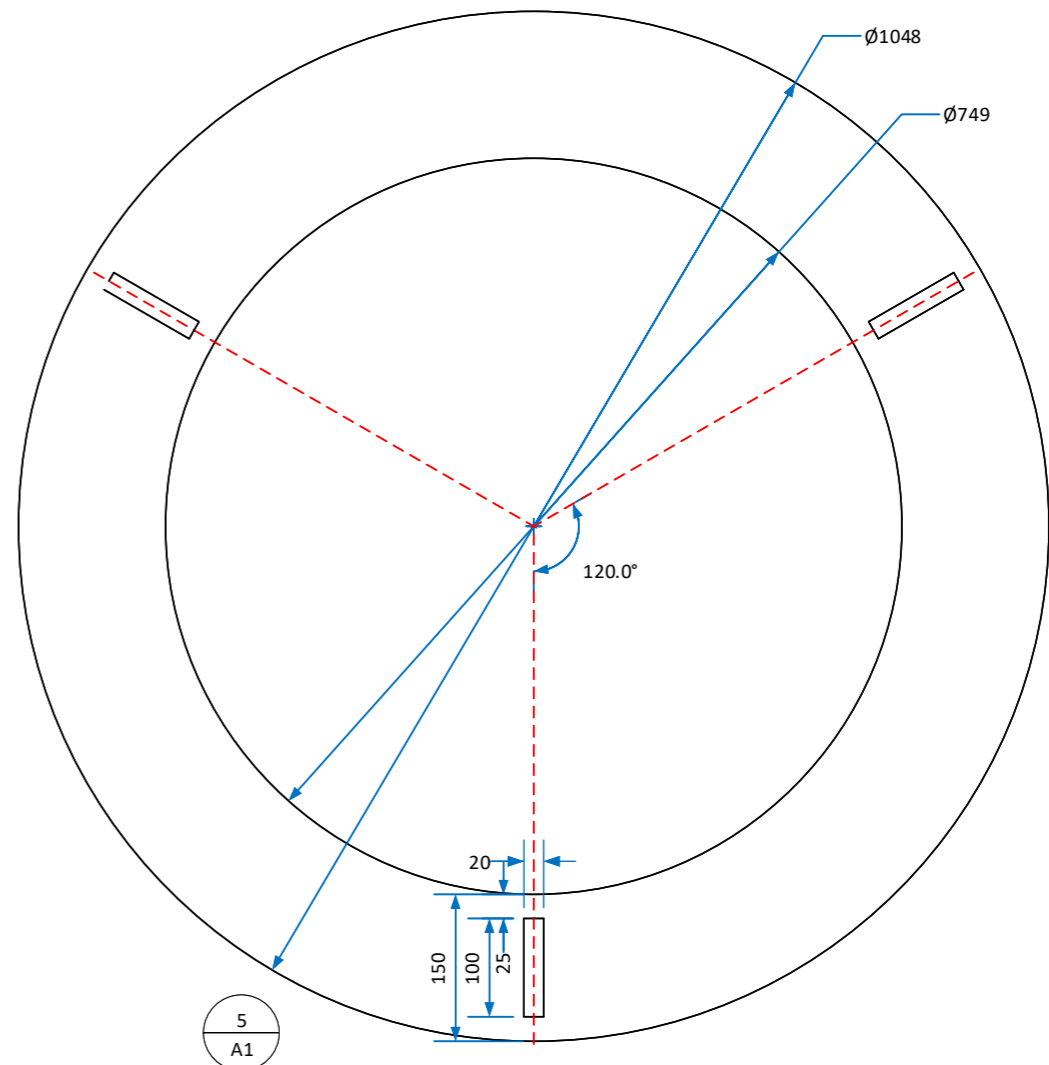

Cut 1 of 1048 mm diameter out off 10 mm mild steel plate with slots as per drawing.

- Buy 12 M16 x 90 mm Bolts.
 Buy 24 M16 Flat Washers.
 Buy 12 M16 Spring Washers.
 Buy 12 M16 x Nuts.

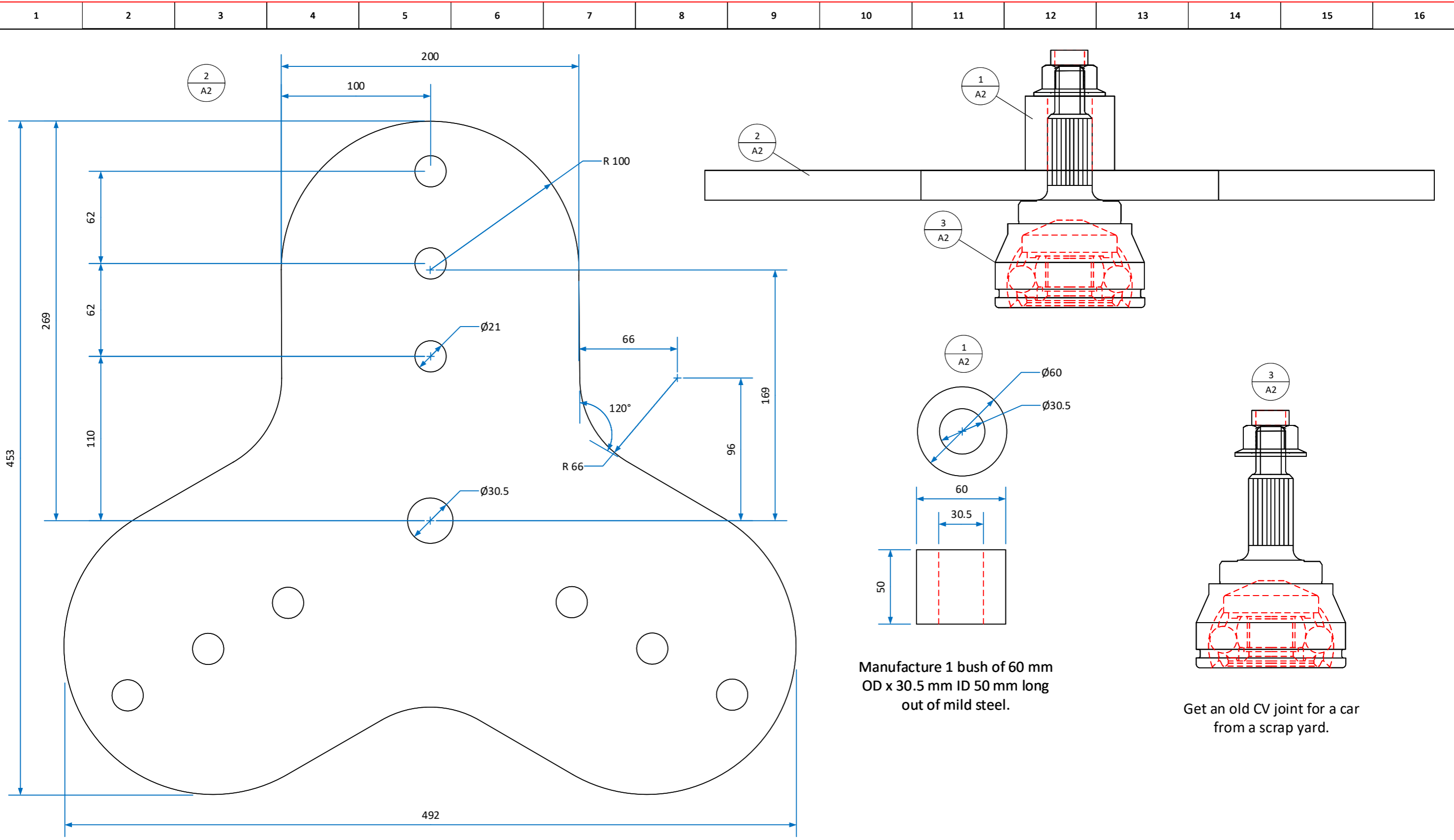

Cut 1 of 492 x 453 mm out off 20 mm mild steel plate with holes as per drawing.

Manufacture 1 bush of 60 mm OD x 30.5 mm ID 50 mm long out of mild steel.

Get an old CV joint for a car from a scrap yard.

A

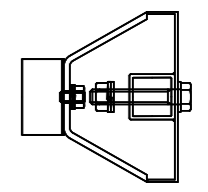
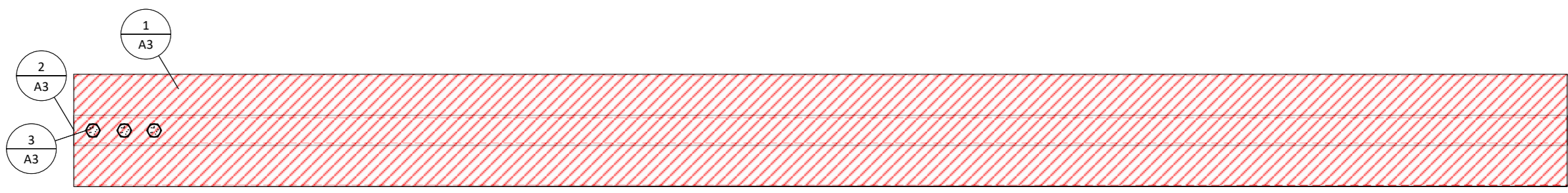

B

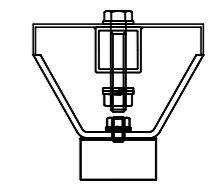
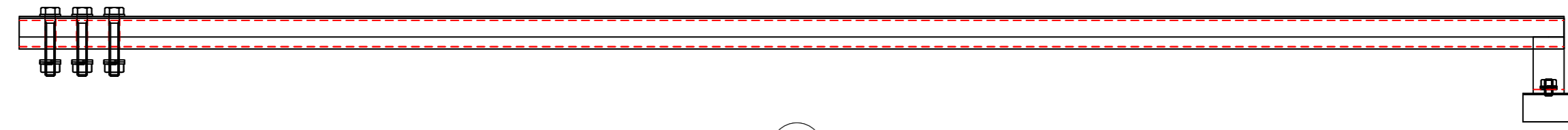

C

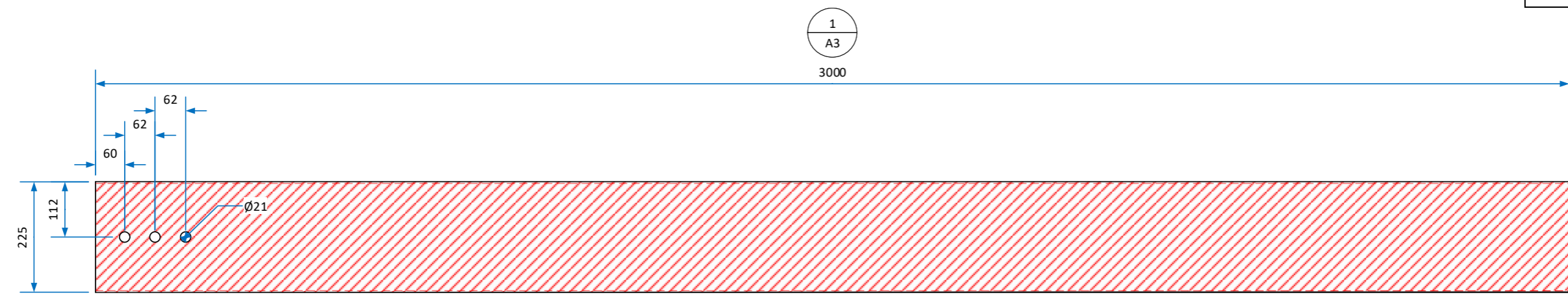

1
A3
3000

Buy 3 off 3000 mm Steel scaffold plank and drill holes as per drawing.

D

2
A3
3000

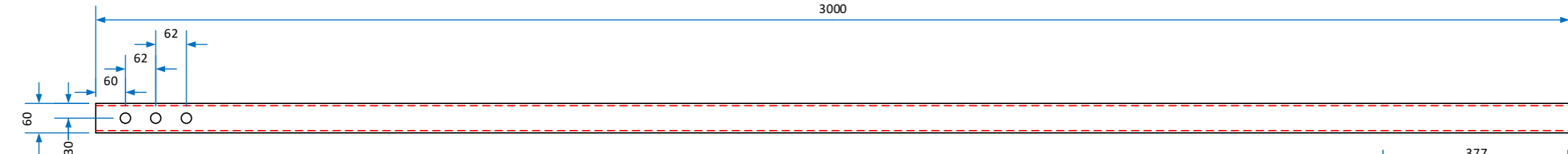

Drill holes in a 3000 x 60 x 60 x 4.5 mm square tubing as per drawing. Do this on 3 square tubing's.

3
A3

- Buy 9 M20 x 120 mm Bolts.
- Buy 18 M20 Flat Washers.
- Buy 9 M20 Spring Washers.
- Buy 9 M20 x Nuts.

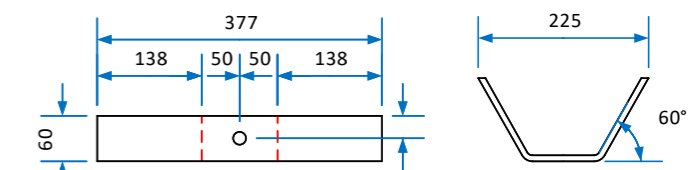
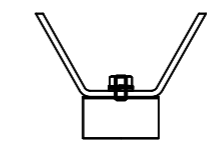

Cut 3 of 377 x 60 mm out of mild steel plate with hole. Bend both ends up 60°. Install rubber mounting at the bottom.

F

Bosun Brick Midrand
a division of
Bosun Concrete Products (Pty) Ltd
Expect the Best

reHJon Balance Beam

Beams

Project: reHJon Balance Beam
For Quotation
Designed: H Jonker Rev: 1

DRW No. 2019070303
Page. 4
Scale. 1:15
of 6 pages

A

A

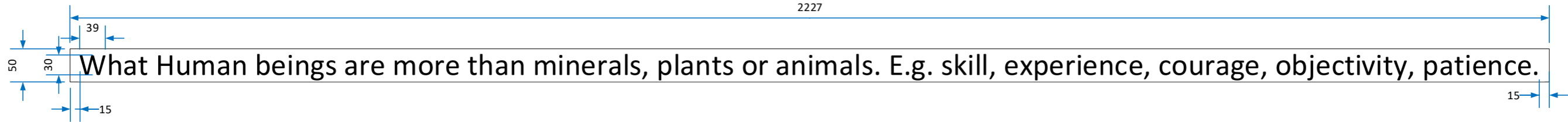

Cut 2 off 200 x 50 mm out of 2 mm Aluminium with lettering as per drawing.

B

B

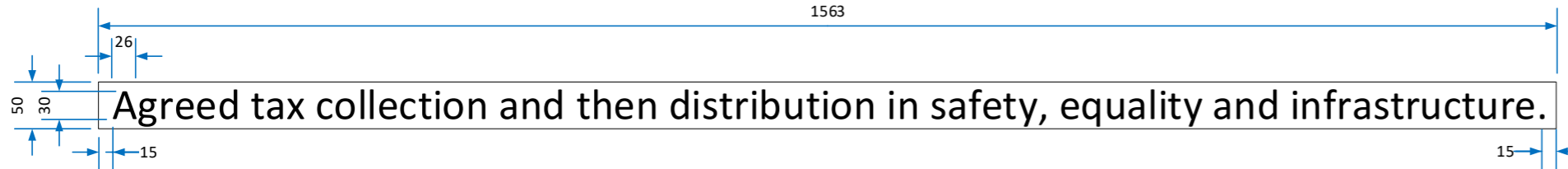

Cut 2 off 200 x 50 mm out of 2 mm Aluminium with lettering as per drawing.

C

C

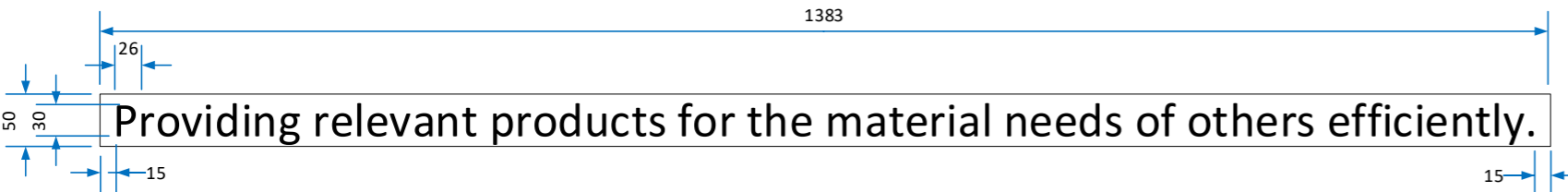

Cut 2 off 200 x 50 mm out of 2 mm Aluminium with lettering as per drawing.

D

D

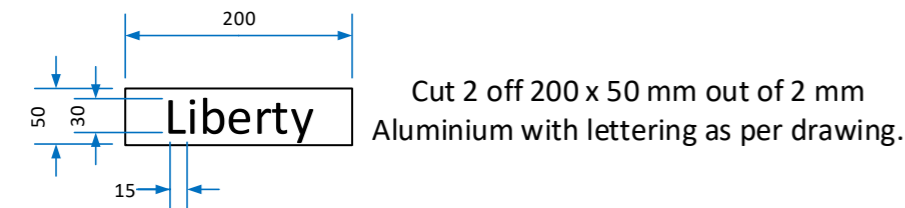

Cut 2 off 200 x 50 mm out of 2 mm Aluminium with lettering as per drawing.

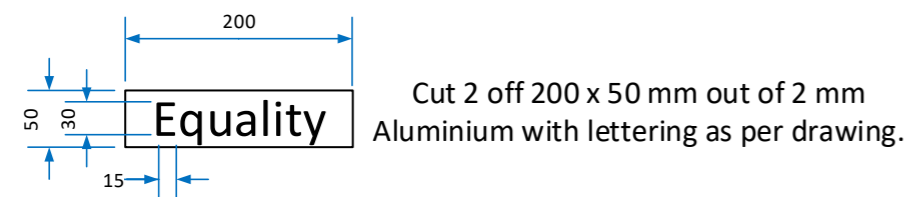

Cut 2 off 200 x 50 mm out of 2 mm Aluminium with lettering as per drawing.

E

E

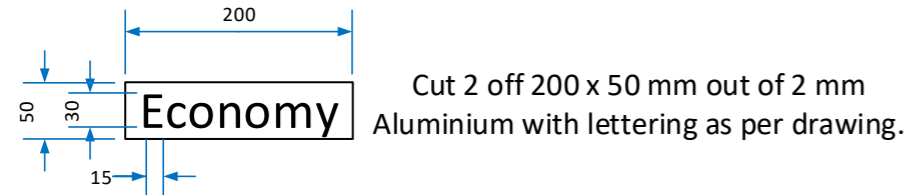

Cut 2 off 200 x 50 mm out of 2 mm Aluminium with lettering as per drawing.

F

F

A

A

B

B

C

C

D

D

E

E

F

F

Liberty What Human beings are more than minerals, plants or animals. E.g. skill, experience, courage, objectivity, patience.

Equality Agreed tax collection and then distribution in safety, equality and infrastructure.

Economy Providing relevant products for the material needs of others efficiently.